

GC-1037 Metal Detector

USER'S MANUAL

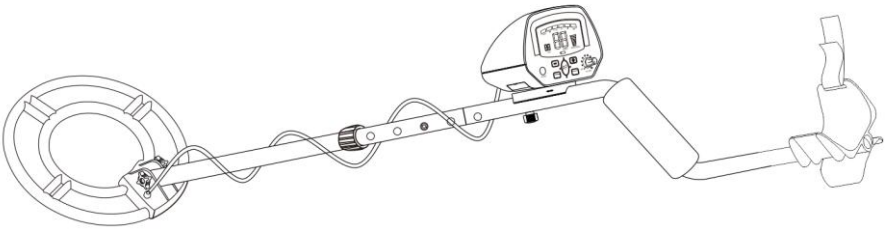

Please read before using the detector

With your GC-1037 metal detector, you can hunt for coins, relics, jewelry, gold, and silver just about anywhere. The detector comes with high sensitivity and strong ability of discrimination. It is versatile and easy to use.

The detector's features include:

LCD Display: Shows the probable type of metal, the depth of the target, range of DISC & NOTCH, the level of SENS , and battery condition . It also has numeric display for target.

Three Tone Audio Discrimination: Sounds three distinctive tones (high, medium and low) for different types of metal.

Notch: Ignores junk metal and finds valuable items by setting the notch range.

DISC: Discriminates the unwanted target by setting the DISC numeric range. The detector will not detect the target beyond the numeric setting.

LIGHT: Used in dark area.

PP: Pinpoints the location of the target accurately.

Super Slow Sweep Identification: With a very slow sweep of the search coil to discriminate different types of metal.

Headphone Jack: Lets you connect headphones (not supplied) of 3.5mm and operate without trouble.

250mm Waterproof Search coil: Lets you use the detector even if you must put it under shallow water.

Adjustable Shaft: Lets you adjust the length of shaft for comfortable use.

Power: Your metal detector requires two 9-volt alkaline batteries (not included).

PREPARATION

ASSEMBLING THE DETECTOR

Assembling your detector is easy and requires no special tools. Just follow these steps.

1. Insert the latch on the top of the handle into the assembly hole on

the bottom of the control box. Then slightly push the control box in the direction of IN marked on the handle to fix the latch in place. Secure the control box with fixing screw properly.

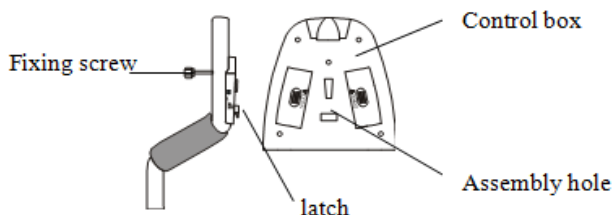

2. Unscrew the fixing knob on the search coil and remove the knob connector. Place the washers into the groove of the lower stem. Then insert the stem and align the holes on the search coil bracket and the stem. Push the connector through the holes and tighten the knob.

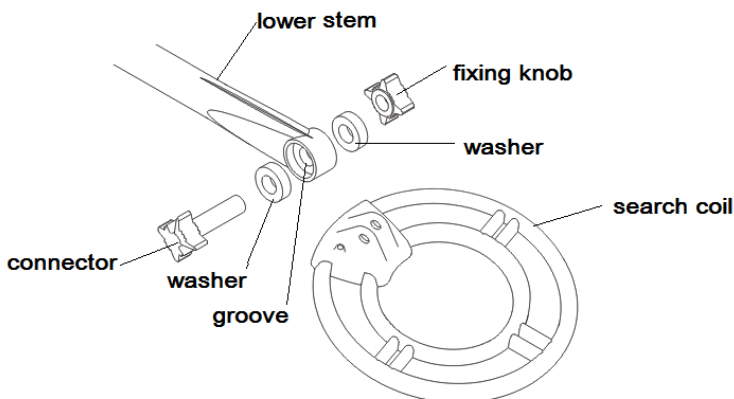

3. Press the silver button in the middle stem, and slide the stem into the upper stem.
4. Press the silver button in the lower stem, and slide the stem into the middle stem.
5. Wind the search coil cable around the stem. Leave enough slack in the cable. Insert the search coil cable plug into the five pin jack on the control box.

- Turn the stem's lock nut on the middle stem clockwise until it loosens. Adjust the stem to a length that you feel comfortable when you stand upright with the detector in your hand, and the search coil is level with the ground with your arm relaxed at your side. Then counter-clockwise rotate to tighten the lock nut.

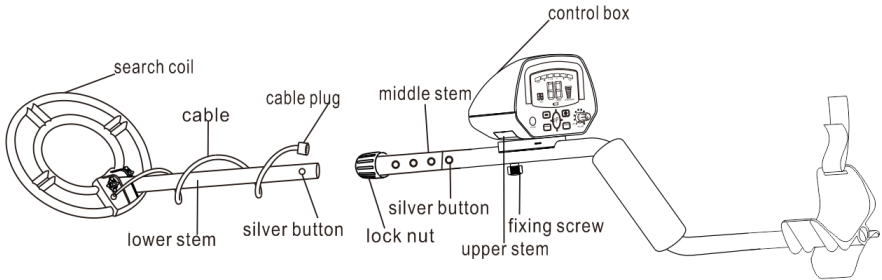

Caution:

- Do not over-tighten the search coil or use tools such as pliers to tighten it.
- The search coil's plug fits into the connector only in one way. Do not force the plug and also do not pull on the cable or you could damage it.

INSTALLING THE BATTERIES

- Turn off the power before installing the batteries.
- Slide the left and right battery covers off in the direction of the arrow.
- Place a 9V battery into the battery compartment matching the polarity symbols (+ and -) marked inside.

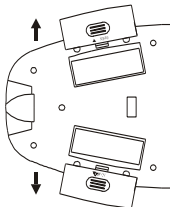

Warning:

- Dispose of old batteries promptly and properly. Never bury or burn them.

Cautions:

- Use only fresh alkaline batteries of required size.
- Do not mix the old and new batteries or different types of batteries.
- If you don't plan to use the unit for a week or more time, remove the batteries. Batteries can leak chemicals that can destroy electronic parts.
- Change the batteries if the battery indicator on the LCD lights.

USING HEADPHONES

1. It is recommended to choose the headphones with volume control.
2. Insert the headphones' 3.5mm plug into the PHONE jack. At this time the internal speaker disconnects.

Listening Safely

- To protect your hearing, set the volume to the lowest setting
- Before you begin listening, adjust the volume to a comfortable level.
- Do not listen at extremely high volume levels. Extended high volume listening can lead to permanent hearing loss.
- Do not wear headphones while operating your detector near high-traffic areas. Pay attention to traffic safety.

INSTRUCTIONS FOR CONTROL PANEL

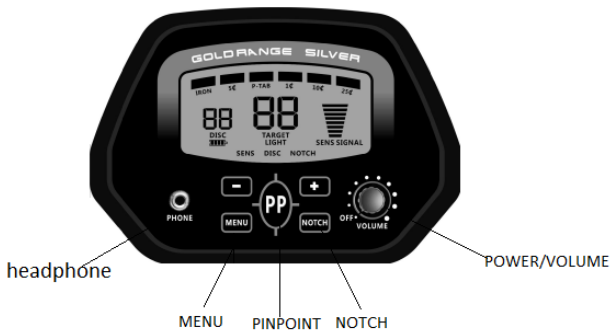

1. VOLUME/POWER switch

Rotate volume control away from OFF to power on the detector.

2. **PHONE** jack: You can insert the headphones' plug of 3.5mm into the PHONE jack and operate without trouble. At this time the internal speaker is disconnected.

3. LCD DISPLAY

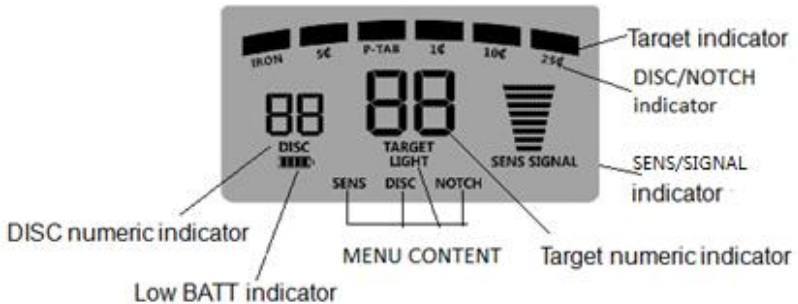

4. CONTROL BUTTONS

MENU: Press MENU, LCD will display LIGHT, SENS, DISC, NOTCH. One of the displayed item will flash. If no button is pressed in about 5 seconds, the flashing item will be selected.

SENS: Press MENU to select SENS. Then press + or – to adjust the level of sensitivity. The level will be displayed on the LCD.

DISC: Discriminates the unwanted target by setting the numeric range. Press MENU to select DISC. Then press + or – to adjust the numeric range of discrimination. The number will be displayed on the LCD.

NOTCH: Eliminates the target you don't want. Press MENU to select NOTCH. Then press+ or – to select the target to be notched. The cursor above the selected target will flash. Press NOTCH again, the target name below the cursor will disappear.

PP: Pinpoints the location of the target accurately.

LIGHT: Press MENU to select LIGHT. Then press + or – to adjust the level (0-9) of LIGHT. The level will be displayed on the LCD.

Note: As the backlight consumes more power, it's better to turn off it in light places.

5. MEMORY

The detector will memorize all the settings before power is off.

OPERATION

1. TURNING ON THE DETECTOR

Rotate volume control away from OFF to power on the detector.

After about 2 seconds the detector enters into stand-by state. At this time the default mode is DISC. LCD displays DISC of 00 and SENS of 6 bars.

2. TESTING AND USING THE DETECTOR

To learn how the detector reacts to different metals, you should test it before you use it the first time. You can test the detector indoors and outdoors.

INDOOR TESTING AND USE

1. Rotate the volume control away from OFF to power on the detector.
2. Setting the operating mode:
 - (1) DISC: Press MENU to select DISC, then + or – to set the DISC numeric value. If the DISC value is set to 00, the detector can detect all kinds of metal. In this case, when the detector finds a target, the cursor above the target name lights. Also the detector sounds a tone, low for iron; medium for 5 cent, nickel, pull tabs, zinc; high for 25¢ or silver object. If you don't want to find the target listed on the LCD, you can set the relative numeric range of DISC by pressing DISC then + or -. For example, the numeric target range for 5¢ is 11-20, you can simply press MENUS to select DISC, then set the DISC number to 21 by pressing + or -. In this case, the numeric range is beyond 5¢. The detector will not have response to it. Neither

will the detector have response to iron. Because the target numeric range for iron is 0-10.

(2) NOTCH:

Press MENU to select NOTCH, then + or – to select the target to be notched. The cursor above the selected target will flash. Press NOTCH again, the target name below the cursor will disappear. It means this target will be notched during the detection and the detector will have no reaction to the notched target. If you want to pick up the target notched, simply press NOTCH again. Press + or -, the cursor will move from left or right. If NOTCH is not pressed within about 3 seconds, the detector will enter standby state.

Note:

1. It is not recommended to notch all targets listed on the LCD. Because if you notch everything, you can't find anything.
2. If you want to select the setting of DISC or SENS after pressing NOTCH, you have to wait for about 3 seconds until the cursor above the target goes out.
3. Press MENU to select SENS, then press + or – to set the sensitivity. The default level is of 6 bars.
4. Place the detector on a wooden or plastic table, then remove any watches, rings, or metal jewelry you are wearing.
5. Adjust the search coil so the flat part points towards the ceiling.

Note:

Never test the detector on a floor inside a building. Most buildings have metal of some kind in the floor, which might interfere with the objects you're testing or mask the signal completely.



6. Slowly sweep a sample of the material you want the detector to find (such as a gold ring or a coin) 2-3 inches or more above the face of the search coil. When the detector detects any metal, it sounds a tone and the cursor above the target name will light. Also LCD displays the numeric value of target as well as the signal strength of it. Please note that the signal strength is only a reference.

Note:

If you are using a coin, the detector will detect it more easily if you hold it so a flat side is parallel with the flat side of the search coil. A sweep with the side of coin over search coil might cause false indication and unstable display of target.

7. PP(PINPOINT)

After you find a metal object, you can use PP to pinpoint the target. Hold down PP button. Slowly move the search coil above the sound area. The detector sounds and the signal indicator on the LCD displays the level of signal. Then release the button. Sweep the search coil again, keeping the same distance of search coil, sound disappears. Hold down PP again, closer the search coil to the sound area, the detector sounds again. Repeat the above steps until the detector displays the stronger signal where the location of the target is.

Press MENU to quit the PP mode.

Note:

- It's normal phenomena that LCD displays 1 or 2 signal bars and beep sound appears after holding down PP. This will not affect the operation.
- You can hold down and release PP several times to eliminate the initial weak signals and beeps before pinpointing.
- To find the exact location of target, you need to practise more times.

TARGET INDICATIONS

1. Numeric ranges of target:

- IRON: 00-10

- 5¢:	11-20
-P-TAB:	21-40
-ZN(1¢):	41-60
-10¢:	61-75
-25¢:	76-99

Note: There are a wide variety of metals and no target can be identified for certain until unearthed. This table is for general reference only.

2. Types of target

- **IRON:** It indicates that the target is probably iron.
- **5¢:** It indicates that the target is probably 5¢ or a nickel. Some small gold rings might register within this range.
- **P-TAB:** It indicates that the target is probably a pull tab of an aluminum can. Some small gold rings might register within this range.
- **1¢:** It is indicated that the target is probably a coin of 1¢ or type of metal of zinc alloy. Some medium sized gold rings might register within this category.
- **10¢:** It indicates that the target might be a coin of 10¢. Some large rough gold items might register within this category.
- **25¢:** It indicates that the target is probably 25¢ or a silver coin.

3. Tones

The detector comes with three tones for different types of metal. But the built in audio identification system sounds a unique tone for each of three categories of metal. This makes it easier to identify the metal being detected.

A low tone is for IRON, 5¢, same as for foil, bottle cap or nickels. A medium tone is for P-TAB, ZN, 1¢ (aluminum pull tabs, zinc or copper items). A high tone is for 25¢ 10¢, same as for brass or silver items.

Notes:

- When you set the detector to DISC or NOTCH mode, the

detector sounds a medium or high tone when it detects highly oxidized iron.

- Depending on the purity, about 15 percent of gold rings cause the detector to sound a medium tone.

OUTDOOR TESTING AND USE

1. Rotate the volume switch away from OFF to power on the detector.
2. Follow the steps of 2 described in section of **Indoor Testing and Use** to set the operating mode.
3. Find an area on the ground outside where there is no metal.
4. Place a sample of the material you want the detector to find (such as a gold ring or a coin) on the ground.

Note:

If you are using valuable metal such as gold to test the detector, mark the area where you place the item, to help you find it later. Do not place it in tall grass or weeds).

5. Hold the search coil level to the ground about 1~2 inches above the surface, slowly move the search coil over the area where you placed the sample, sweeping the search coil in a side-to-side motion.

Search coil Sweeping Hints:

- Never sweep the search coil as if it were a pendulum. Raising the search coil while sweeping or at the end of a sweep will cause false readings.



- Sweep slowly, hurrying will cause you to miss targets.
- It's better you sweep the search coil from side to side in an arc line of 3 inches motion and keep the search coil parallel with the

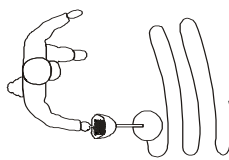

ground

If the detector detects the item, it sounds a tone, and the cursor above the target name will light. Also LCD displays the numeric range of target as well as the depth(signal strength).

If the detector does not detect the item, make sure that the mode is set correctly for the type of metal you're searching for. Also make sure that you're moving the search coil correctly.

Notes:

- The detector responds with a signal when it detects most valuable metal objects. If a signal does not repeat after you sweep the search coil over the target a few times, the target is probably junk metal.
- False signals can be caused by trashy ground, electrical interference, or large irregular piece of junk metal.
- False signals are usually broken or non-repeatable.

Adjusting SENSITIVITY

After you become familiar with how your detector works, it's important to fine tune the sensitivity to get a good effect.

Press MENU to select SENS. Then press + or - to increase or decrease the sensitivity. The level will be displayed on the LCD.

Note:

In order to detect the target deeply buried, you can adjust the SENS to a high level. But not to set the level of SENS to Max. position, or the detector will receive interference and false signal from broadcast antenna and other electronic lines. The detector will have unstable and irregular indications.

Using LIGHT

In dark area, you can use LIGHT for better searching. Press MENU to select LIGHT. Then press + or – to adjust the level (0-9) of LIGHT. The level will be displayed on the LCD.

Note: As the light consumes more power, we suggest you setting the

value to 0 in normal environment.

Factors That Affect The Detecting

It's difficult to have an accurate detecting result. Sometimes the detecting may be restricted by some factors:

- The angle of the target buried in the soil.
- The depth of the target.
- The level of oxidization of the target.
- The size of the target.
- Electro-magnetic and electrical interference surrounding the target.

In area of highly mineralized ground, or fertile ground, or wet sand, the detector will sound even if there is no metal. In this case, you can lower the sensitivity or increase the DISC numeric value. Meantime enhance the distance between the search coil and the ground. In area with trashy metal, you can set DISC numeric value to 50. In this case most nails and small pieces of iron will be eliminated.

Metallic digging tools will also affect the detection if they are near the search coil. So it's better place them a little far away.

CARE AND MAINTENANCE

Your metal detector is an example of superior design and craftsmanship. The following suggestions will help you care for your metal detector so you can enjoy it for years.



Handle the detector gently and carefully. Dropping it can damage circuit boards and cases and can cause the detector to work improperly.



Use the detector only in normal temperature

environments. Temperature extremes can shorten the life of electronic devices, damage the cases of the detector.



Keep the detector away from dust and dirt, which can cause premature wear of parts.



Wipe the detector with a damp cloth occasionally to keep it looking new. Do not use harsh chemicals, cleaning solvents, or strong detergents to clean the detector.

